

VOX



LUXURY VINYL FLOORING. VITERRA

Product presentation.

October 2018



VITERRA. VINYL FLOORING

This floor will tolerate much more than laminate panels or wood. It is extremely resistant to dents, scratches and water. As a result it is a great solution for even the most demanding places, such as a bathroom, kitchen or hall.



LIGHT CONCRETE

VITERRA. THE COMFORT YOU NEED

Viterra vinyl floors are warm, quiet and comfortable. They are easy to keep clean, do not attract dust and have antiallergic properties. They are suitable for underfloor heating as they deliver heat quickly and more efficiently.

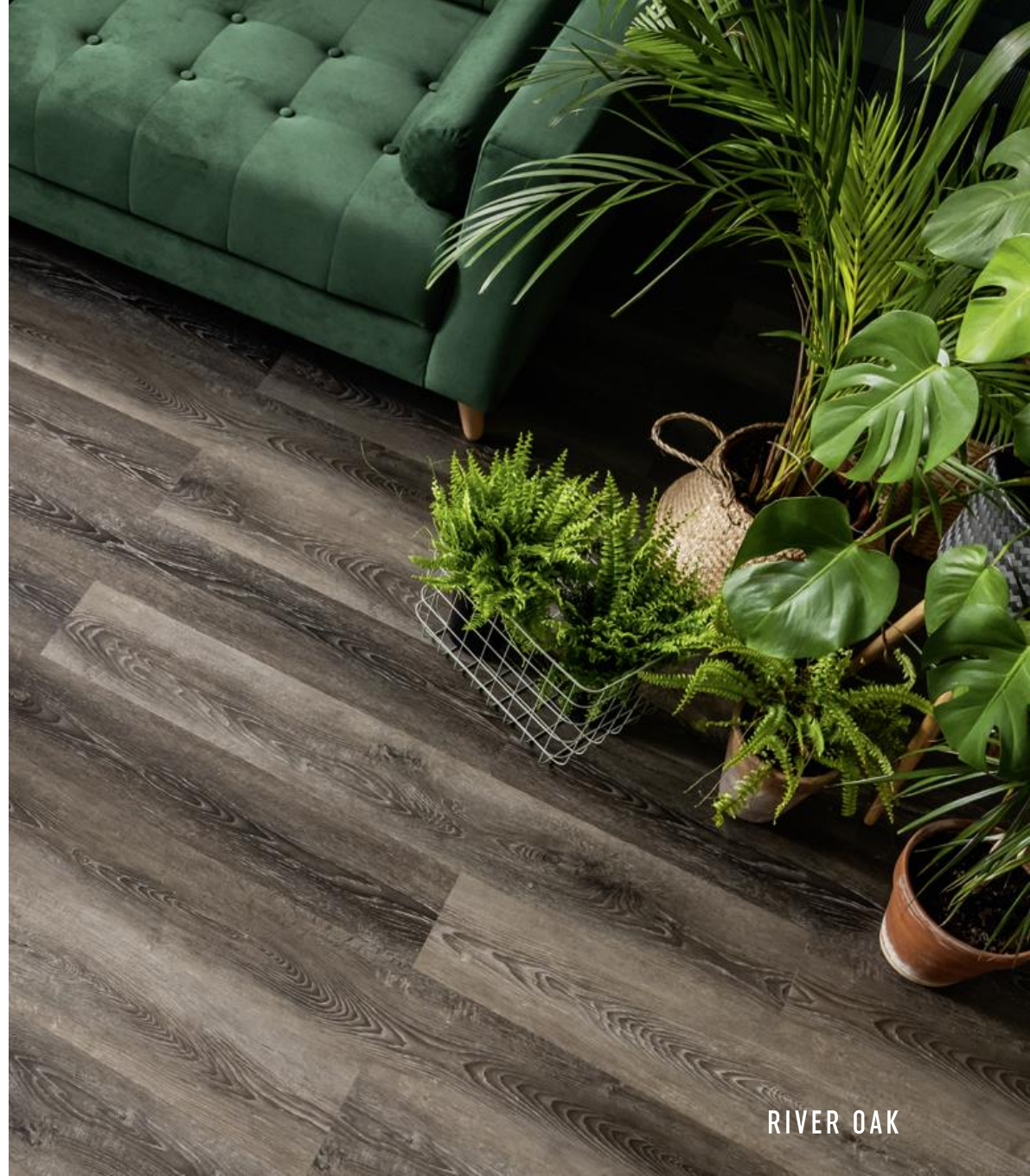

RIVER OAK



NATURAL OAK

WOOD LINE

1220 x 180 mm



CREAM OAK



WHITE OAK



LIGT GREY OAK



GREY OAK



KNOTTY OAK



ASIAN OAK

WOOD LINE

1220 x 180 mm



NATURAL OAK



DARK OAK



AMERICAN OAK



RIVER OAK



OLD OAK



NUT

STONE LINE

610 x 305 mm



LIGHT CONCRETE



DARK CONCRETE



CONCRETE INSCRIPTION



HARD CONCRETE



LIGHT CONCRETE

KEY FEATURES



MOISTURE
RESISTANT



SUITABLE FOR
UNDERFLOOR
HEATING



10 YEARS
WARRANTY



CLICK SYSTEM



THICKNESS 4,2 MM



WEAR LAYER 0,3 MM

THE STRUCTURE OF VINYL FLOORING

DECORATIVE LAYER

The precise printing technique used for this layer gives our vinyl floor its authentic appearance of wood or concrete.

TOP LAYER

Protects your floors from dirt, stains and scratches, makes them easy to clean and maintain, guarantees a natural look.

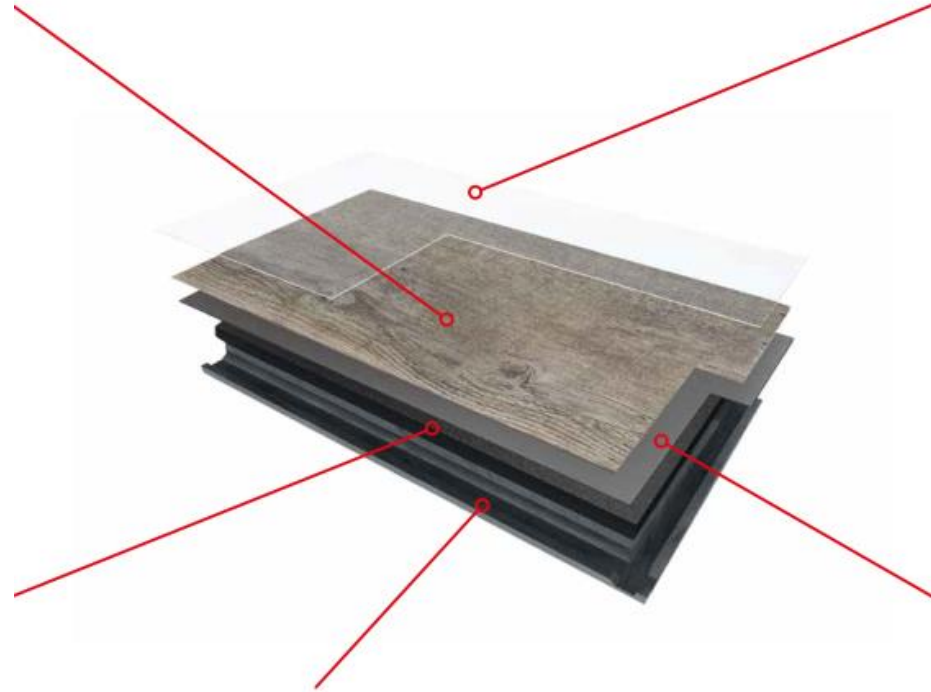

STABILISING LAYER

This layer contains super dense glass fibres to give the vinyl floor additional dimensional stability. And resistance to changing temperatures.

VINYL BACKING

This moisture-resistant layer guarantees a perfectly balanced floor board which prevents cupping or warping.

VINYL CORE

Durable, water resistant and sound-absorbing core guarantees good quality for many years.

ESPUMO SKIRTING BOARDS. IDEAL FINISHING

Espumo skirting boards are a perfect match for vinyl floors. Produced in innovative Kerracore technology, they are light and extremely durable. Due to their water resistance, they are suitable for rooms exposed to moisture. What is more, you can paint them.



ESPUMO MODELS

ESP101

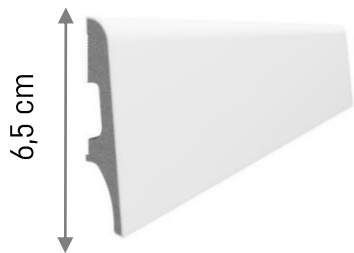

ESP201

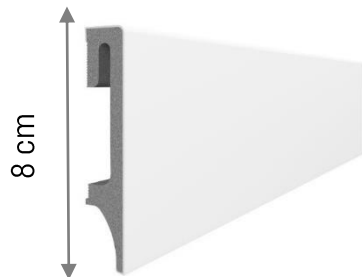

ESP301

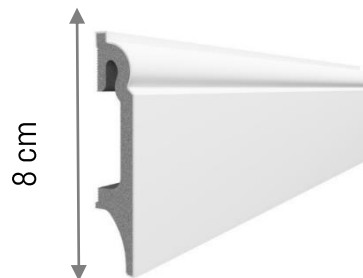

ESP401

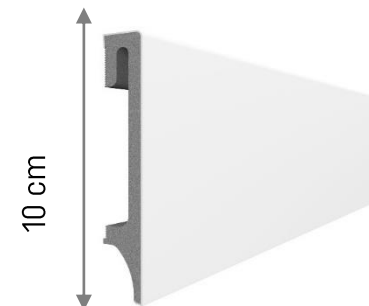

ESP202

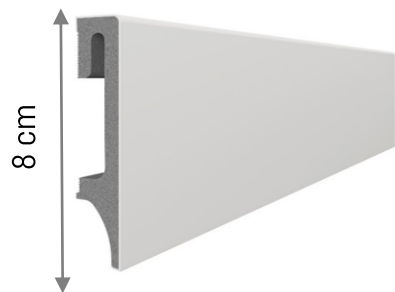

ESP203

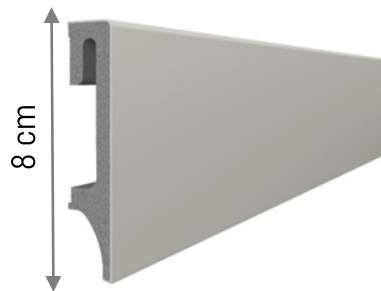

ESP205

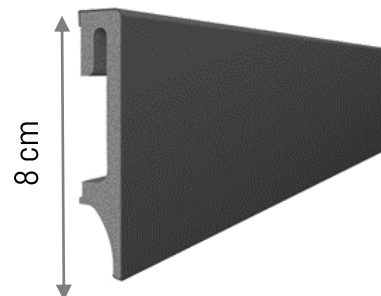

TECHNICAL SPECIFICATION. VITERRA FLOORING

INDEX	NAME	THICKNESS	WEAR LAYER	SIZE	PCS / BOX	AREA / BOX
6004044	Light Grey Oak	4,2 mm	0,3 mm	1220 x 180 mm	10 pcs	2,196 m ²
6004045	Natural Oak	4,2 mm	0,3 mm	1220 x 180 mm	10 pcs	2,196 m ²
6004046	White Oak	4,2 mm	0,3 mm	1220 x 180 mm	10 pcs	2,196 m ²
6004050	Dark Oak	4,2 mm	0,3 mm	1220 x 180 mm	10 pcs	2,196 m ²
6004052	American Oak	4,2 mm	0,3 mm	1220 x 180 mm	10 pcs	2,196 m ²
6004053	Asian Oak	4,2 mm	0,3 mm	1220 x 180 mm	10 pcs	2,196 m ²
6004054	Knotty Oak	4,2 mm	0,3 mm	1220 x 180 mm	10 pcs	2,196 m ²
6004055	Cream Oak	4,2 mm	0,3 mm	1220 x 180 mm	10 pcs	2,196 m ²
6004043	Grey Oak	4,2 mm	0,3 mm	1220 x 180 mm	10 pcs	2,196 m ²
6004048	Old Oak	4,2 mm	0,3 mm	1220 x 180 mm	10 pcs	2,196 m ²
6004051	River Oak	4,2 mm	0,3 mm	1220 x 180 mm	10pcs	2,196 m ²
6004049	Nut	4,2 mm	0,3 mm	1220 x 180 mm	10 pcs	2,196 m ²

TECHNICAL SPECIFICATION. VITERRA FLOORING

INDEX	NAME	THICKNESS	WEAR LAYER	SIZE	PCS / BOX	AREA / BOX
6004040	Dark Concrete	4,2 mm	0,3 mm	610 x 305 mm	10 pcs	1,8605 m ²
6004041	Light Concrete	4,2 mm	0,3 mm	610 x 305 mm	10 pcs	1,8605 m ²
6004042	Concrete Inscription	4,2 mm	0,3 mm	610 x 305 mm	10 pcs	1,8605 m ²
6004047	Hard Concrete	4,2 mm	0,3 mm	610 x 305 mm	10 pcs	1,8605 m ²

PREPARATION FOR INSTALLATION

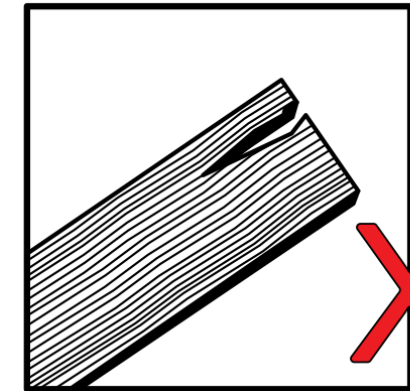
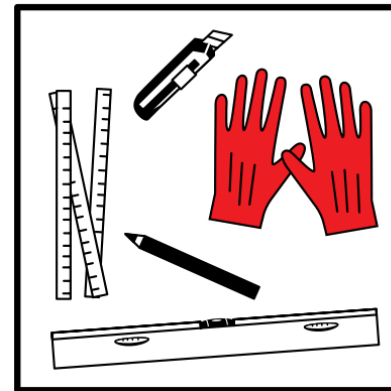
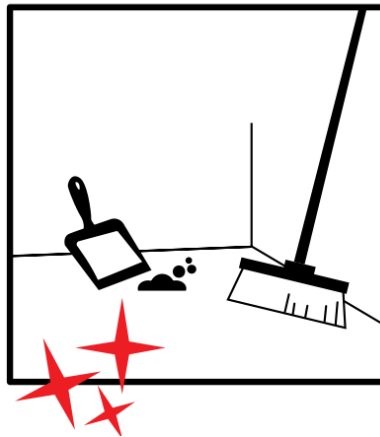
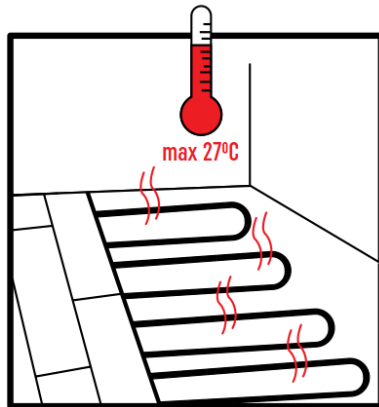
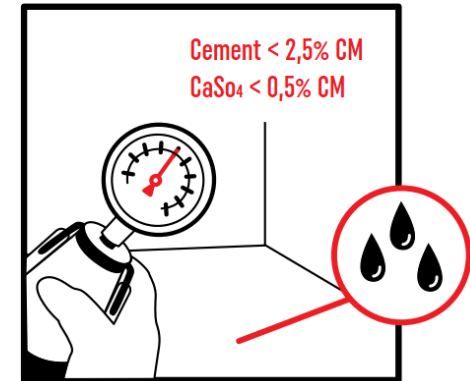
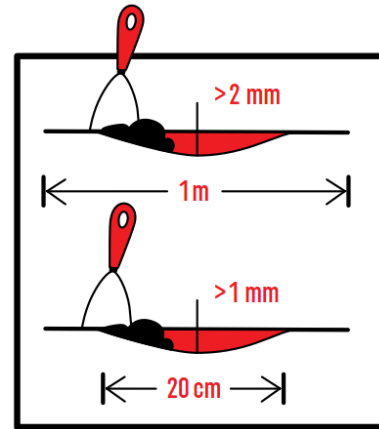
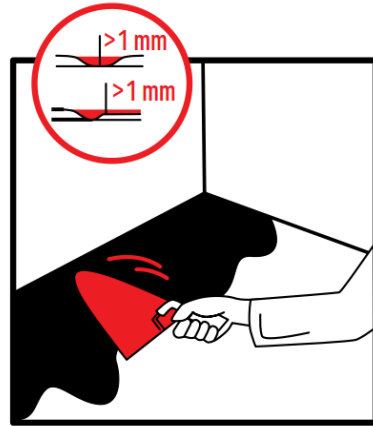
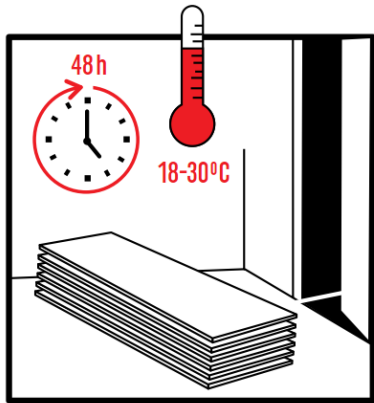

INSTALLATION

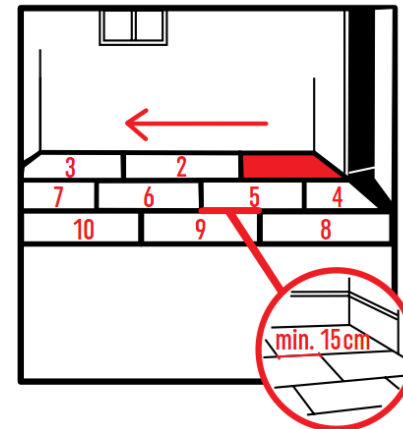
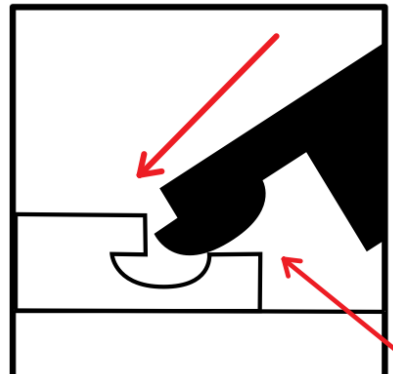
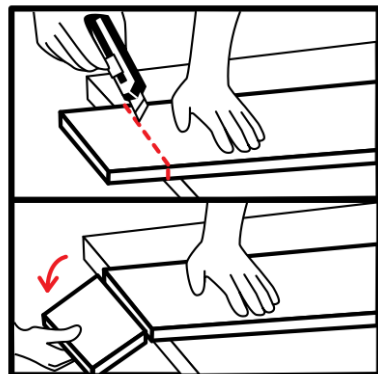
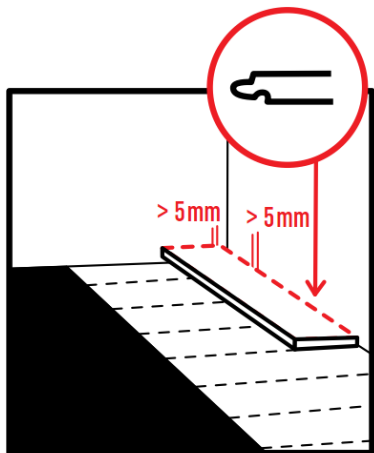

FINISHING AND MAINTENANCE

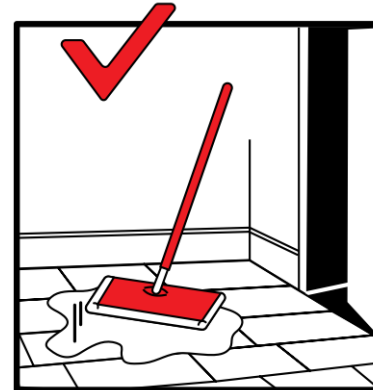
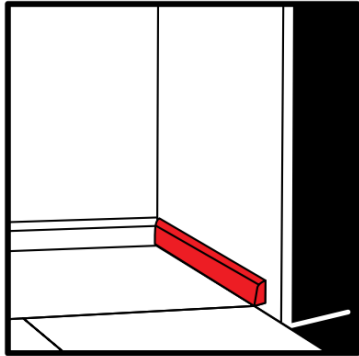

MARKETING MATERIALS

3022084 VITERRA VINYL FLOORING SAMPLE 16 COLOURS
(sample consists of 3 fans)



MARKETING MATERIALS

9020462 KATALOG LVT VITERRA EN
9020560 KATALOG LVT VITERRA SK
9020559 KATALOG LVT VITERRA CS
9020563 KATALOG LVT VITERRA ES



MARKETING MATERIALS

3022083 LVT VITERRA SAMPLE KIT UNI

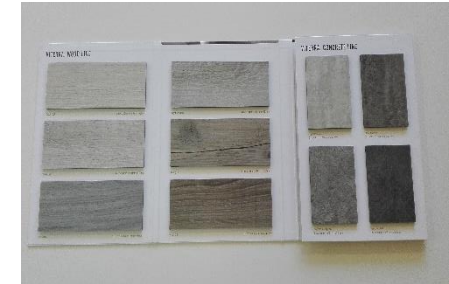

MARKETING MATERIALS



9020391 LVT STAND 16 REFILLS EN

THANK YOU